



X30

OWNER'S MANUAL

Jumbo Acoustic. Immense Sound



EMERALD
— GUITARS —



Congrats/welcome to emerald guitars

Congratulations on becoming the proud owner of an Emerald Guitar! Your decision to join the Emerald community is truly exciting. You've not only acquired a masterpiece of craftsmanship but also a ticket to a world of musical excellence and camaraderie. May your new guitar bring you endless joy, inspiration, and countless musical adventures. Welcome to the Emerald family!

Alister Hay





To make and inspire music

Our Vision

Emerald Guitars envisions a future where hand-crafted artistry meets cutting-edge innovation. Designed and made in Ireland, our instruments blend traditional craftsmanship with modern production techniques, redefining what's possible in music. As pioneers in carbon fiber guitar innovation, we aim to set new standards for tonal richness, durability, and sustainability.

Our vision is to inspire musicians of all levels to achieve new heights in their artistry. By fostering a global community of musicians who share our passion for excellence and creativity, we celebrate both the art and science of crafting exceptional guitars.

With every step forward, we remain dedicated to pushing boundaries, honoring tradition, and expanding the horizons of what music can be.



PLEK'D TO PERFECTION

Every guitar goes through the cutting-edge plek process which scans the guitar's frets and machines them to perfection, taking into account, radius, relief, action height and string gauge.

this process guarantees ultimate accuracy and playability.

X30

Guitar Anatomy

1. Gotoh 510 tuners 18:1 ratio
2. Graphtech low friction nut
3. Stainless steel frets

4.

4. Offset soundhole
5. Innovative neck design
6. Graphtech low friction saddle
7. Ergonomic body

Strings

Daddario XS Phosphor Bronze,
Light top/Medium Bottom 12-56
0.12, 0.16, 0.25, 0.35, 0.45, 0.56

1.

2.

3.

5.

7.

6.

Your Guitar May Also Come With

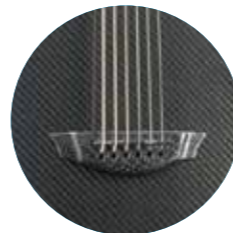

Pinless Bridge

Traditional bridges use pins to secure the ball ends of the strings in holes. Pinless bridges eliminate these, allowing the strings to be inserted directly into slots or holes on the bridge



Fully Adjustable Bridge

The bridge allows full control over the height adjustment (action) and the intonation adjustment. Which gives precise control over the setup, enabling players to tailor the guitar's feel and tone to their preferences.

STRING CHANGES

Pinless Bridge



Tutorial Video

Scan QR code or visit
<https://youtu.be/cG16qLGR5R0>

Adjustable Bridge



Tutorial Video

Scan QR code or visit
<https://youtu.be/0VKQ1lzGhIs>

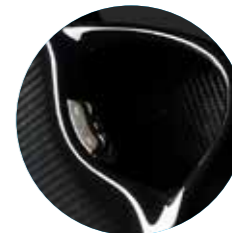

Pickup Knobs

If it's got a pickup then high chance it'll have some kind of knob to turn, full control guide starts the next page



Hyvibe

QR code to
Hyvibe Smart
Guitar Quick
Start Guide
video



SETUP GUIDE

Use this page as a **reference** for what setup your X30 can use. See the control guide pages for instructions.

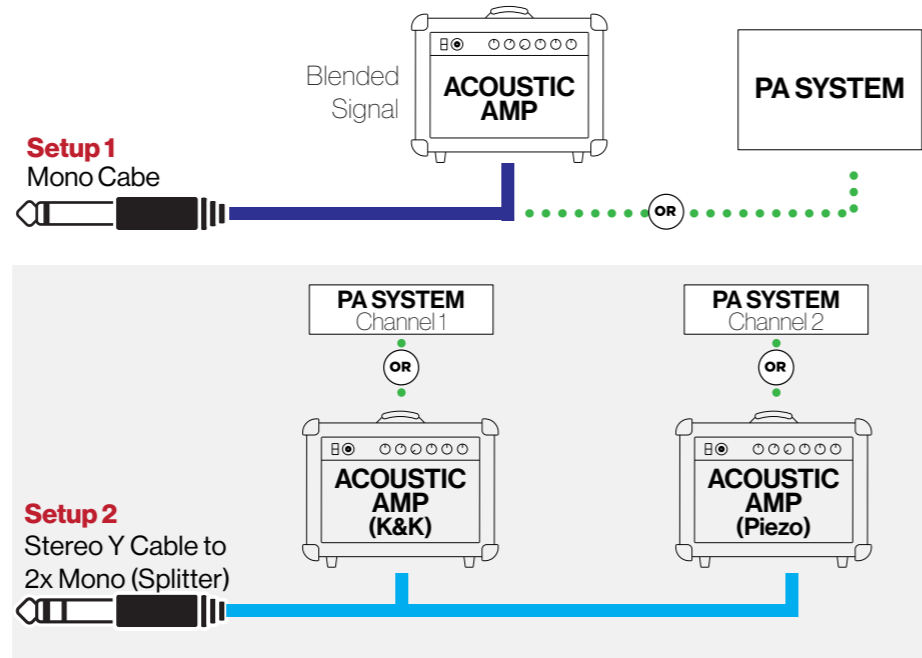
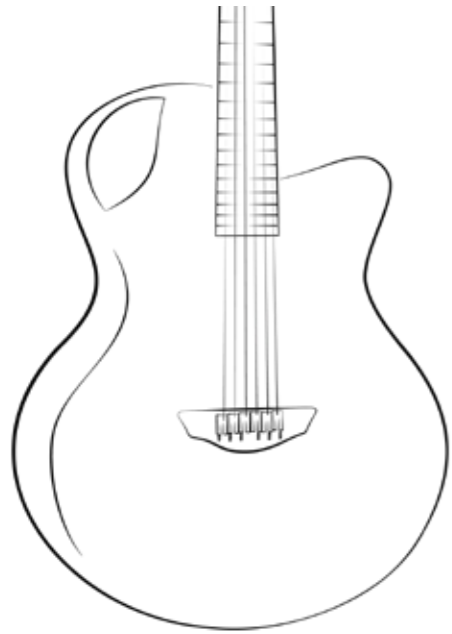

Graph Tech Ghost Piezo CONTROL GUIDE

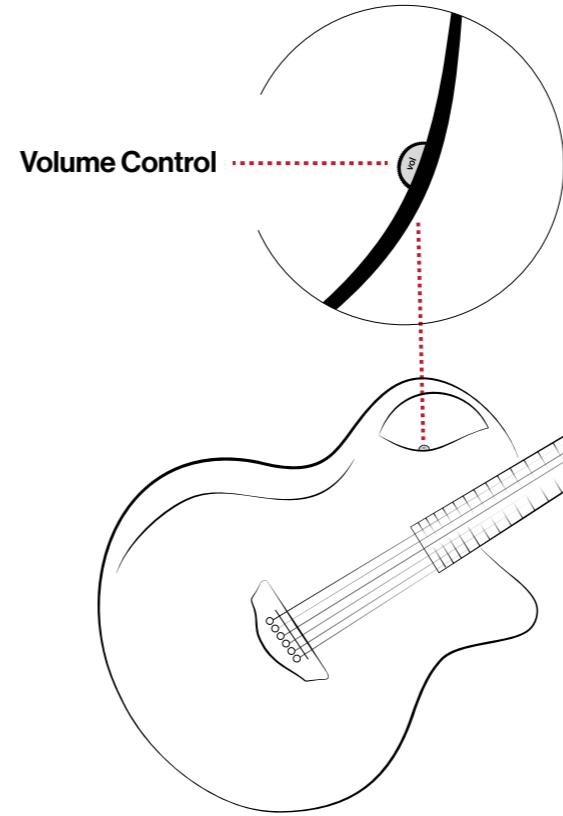

Setup Reference: **Setup 1**

LR Baggs Element CONTROL GUIDE

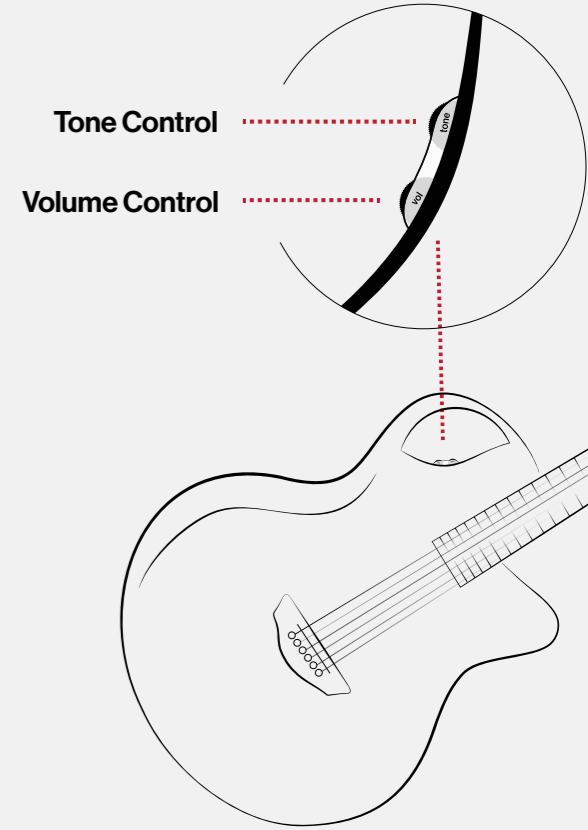

Setup Reference: **Setup 1**

**Ghost piezo with
K&K contact pickup**
CONTROL GUIDE

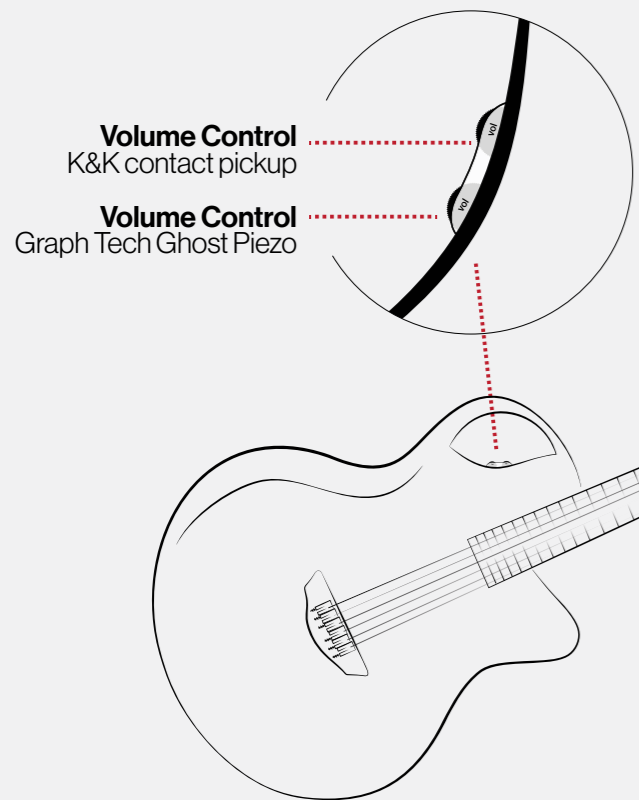

Setup Reference: [Setup 1](#) | [Setup 2](#)



HyVibe Interface

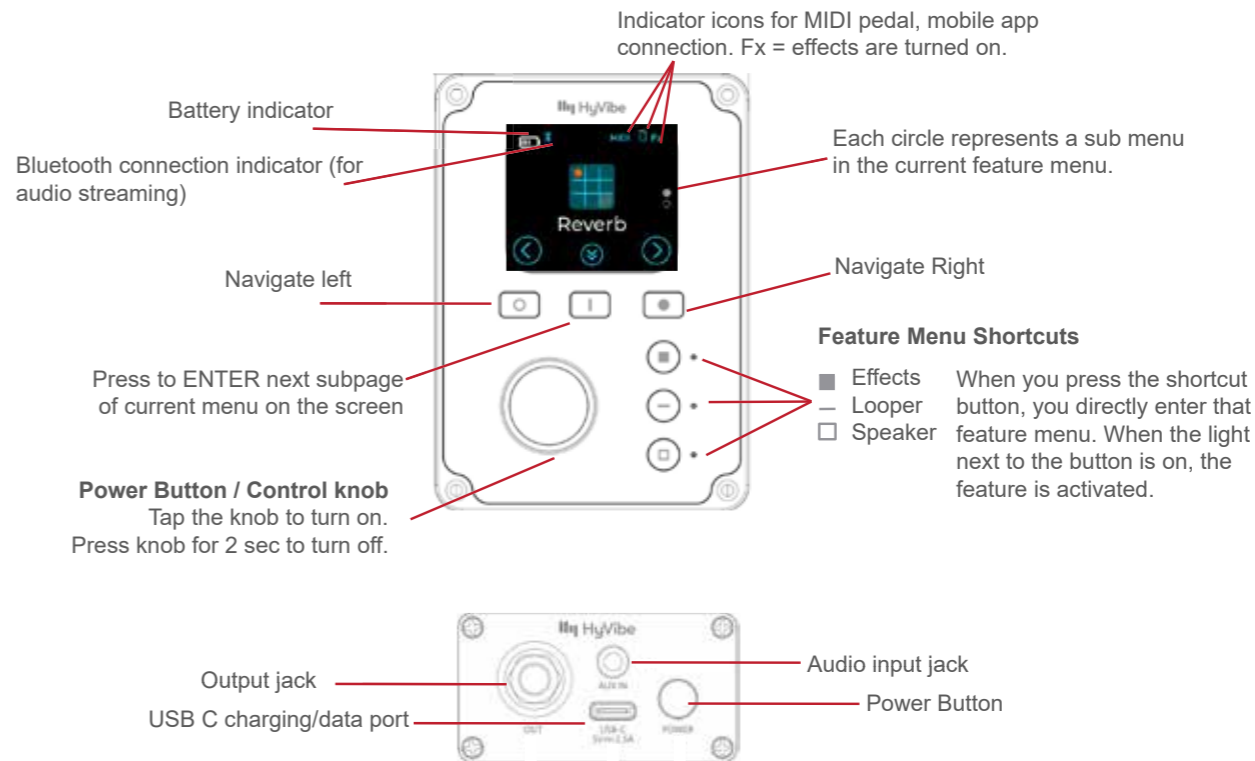

Setup Reference: [Setup 1](#)



HyVibe H2
Adjusts Scan QR code to view user manual



HyVibe H1
Adjusts Scan QR code to view user manual

HiFi Duet CONTROL GUIDE

Mix Control

(Mixes between mic and pickup) Use this wheel to mix between HiFi pickups and Silo microphone. When the mix control is rolled toward the neck, the Silo mic is carrying the majority of the guitar's voice with the HiFi pickups supporting the lower frequencies. When rolled toward the bridge, you will hear the full-range HiFi pickups only. As you experiment with different positions, you will find a wide range of great-sounding and useful settings.

Volume Control

Roll this wheel toward the neck to increase the volume or toward the bridge to decrease the volume.

Silo Mic Level Control

Adjusts the level of the Silo mic relative to the level of the HiFi pickups.

IMPORTANT: Setting this control correctly is vital to the sound of the HiFi Duet. Hidden on the underside of the preamp is a control to adjust the mic gain level. It has 10 positions indicated by detents in the control. Rolling the control away from the neck will give you more mic level and a brighter tone, while rolling it toward the bridge will give you less mic and a darker tone. To set this control, make sure that the mix control is rolled all the way toward the neck and then adjust the mic level control so that you get even tonal balance between the bass, mids, and treble frequencies. This is intended to be a "set it and forget it" control, but it can be adjusted on the fly if needed.

Setup Reference: [Setup 1](#)

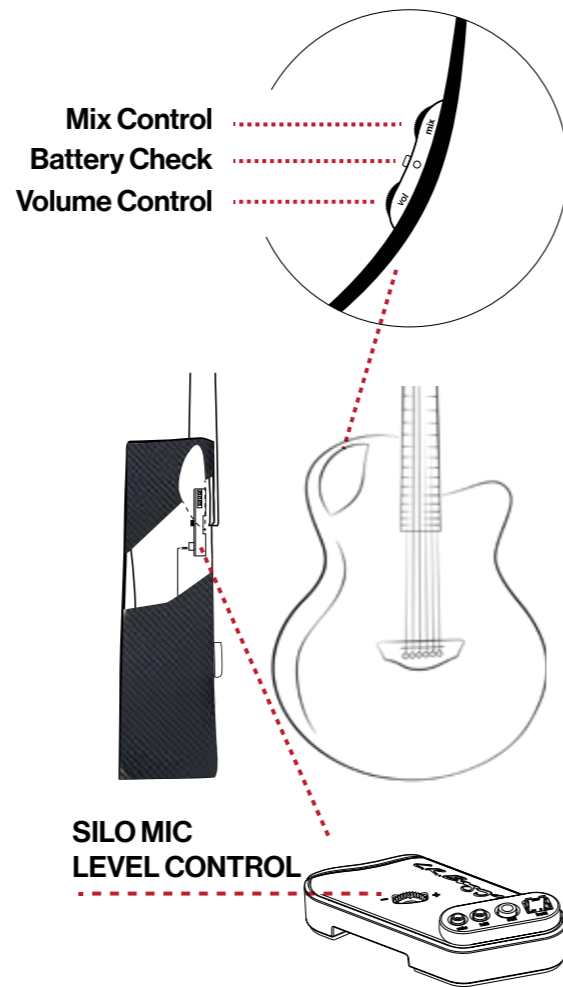

EMERALD RANGE

View full range of instruments at emeraldguitars.com



Stock



3D Builder



TRUSS ROD

This guitar is fitted with a dual action truss rod which uses a 4mm Allen key. While the truss rod can be adjusted to change the relief in the neck and compensate for changes in string gauge we do advise that adjustments are carried out by a professional.

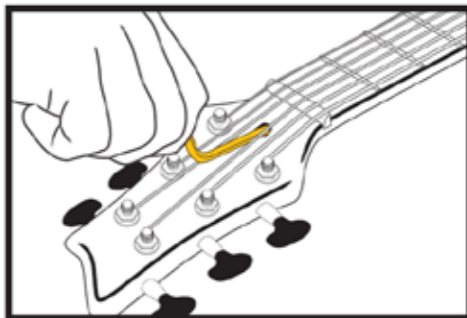

Turn clockwise (right) to reduce relief and flatten the neck — useful if the action feels high in the middle of the neck.

Turn counterclockwise (left) to increase relief and add more forward bow — helpful if you're experiencing fret buzz in the lower frets.

Our guitars have gone through the Plek process which scans the fretboard and assists in the setup process resulting in optimum neck relief for our standard action specifications. Any adjustment to the truss rod will change these specifications and may compromise the playability of your guitar

PLAYLISTS

X30 Playlist

A collection of X30 insightful videos, performances and entertainment



SCAN ME

Shipping Video Playlist

Join us in the shipping room every week as we walk you through the latest carbon fiber guitars shipping worldwide and give exclusive updates on all things Emerald Guitars



SCAN ME

For GraphTech Ghost Piezo equipped guitars with Adjustable saddles:

The adjustable saddles allow for quick and easy changes in both Action (string height) and Intonation. Every Emerald undergoes final setup before leaving us with the intonation and height setup to our recommended specs for the strings used from the factory; however, if any changes are required, they can be easily undertaken with access to only a few tools. Use the included .050" Hex/Allen key to make adjustments to the two screws controlling the saddle height. Turning the screw

clockwise will raise the saddle while counter-clockwise will lower it. Make sure to turn the two screws on each saddle the same amount to balance the saddle height. We recommend using small adjustments at a time on each screw and repeating as necessary.

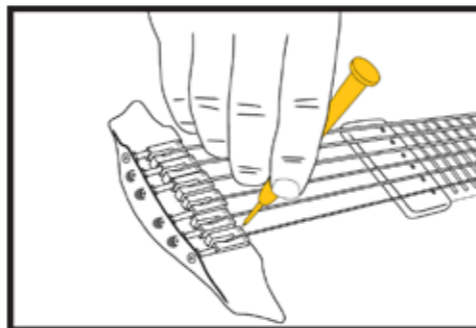

Tutorial Video

Scan QR code or visit <https://youtu.be/OVKQ1lzGhIs>

Changes in intonation may be needed if switching to a different string gauge or other setup adjustments have been made (eg. Neck Relief). You'll need an accurate tuner to check the intonation on each string. First, play the open string and tune it to pitch. Then, play the same string at the 12th fret (octave) and compare the difference. If both are perfectly in tune, no intonation is required. If the note at the 12th fret is out by more than a few cents, it will need to be properly intonated.

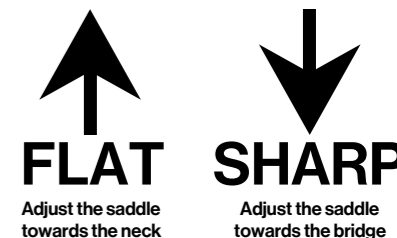
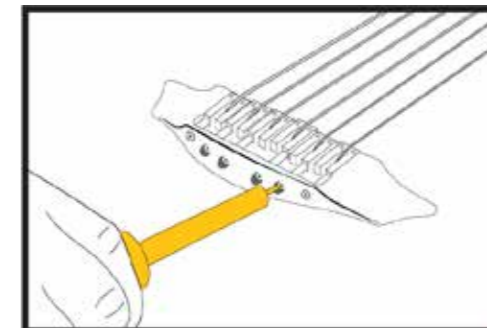

This is done by finely adjusting the saddle to control the string length over the guitar. Use a Phillips head screwdriver to move the saddle either toward or away from the neck. If the fretted note is flat, adjust the saddle toward the neck and away if it is sharp. Make very small adjustments and check the tuning again after each, a 1/4 turn at a time is enough. Repeat for each string until all are intonated properly.



X30
Jumbo Acoustic.
Immense Sound.

EMERALD

**X30 Model Video
With Alistair Hay
Video Guide**



SCAN ME

Stay in Tune with Emerald Guitars!

Don't miss a beat—subscribe to our YouTube channel for the latest updates, news, and behind-the-scenes looks at everything Emerald Guitars. From exclusive product launches to artist collaborations and in-depth guitar features



SCAN ME

CARE AND MAINTENANCE

Your Emerald Guitar has been designed using years of research and experience from our CEO Alistair Hay. Your guitar can last a lifetime through its superior materials but even these need a little maintenance routine to look and play its best.



Cleaning Your Emerald.

After playing, wipe down the guitar's body, neck, and strings with a clean microfiber cloth to remove sweat, fingerprints, and dust.



Dirt. For stubborn smudges or dirt, use a damp cloth with a mild, non-abrasive guitar cleaning solution specifically designed for carbon fiber instruments.

Professional Maintenance. If you notice any significant issues or changes in your guitar's performance, consult a qualified luthier or technician experienced in working with carbon fiber instruments for professional assessment and repair or contact sales@emeraldguitars.com

String Maintenance. Replace the strings regularly, as needed, to maintain a clear and vibrant tone. The frequency of string changes will depend on your playing style and the type of strings you use. Clean the strings with a soft cloth or string cleaner after playing to remove debris and sweat.

Temperature Considerations. Avoid exposing your guitar to extreme temperatures, such as leaving it in a hot car or subjecting it to freezing cold conditions.

Storage. Store your carbon fiber guitar in its case or gig bag when not in use to protect it from dust and potential accidents.

Polishing. Choose a high quality car polish or detailer. Avoid using abrasive polishes or household cleaners, as they can damage the finish. Polishing your carbon fiber guitar helps maintain its aesthetic appeal and keeps it looking its best.

Travel Considerations. When traveling with your carbon fiber guitar, use a well-padded and properly fitting case to protect it from potential damage during transport.



Scan QR Code to visit the Emerald Guitars Ambassador page, where you'll learn more about what an ambassador is, how to meet one and how to join the Ambassador Programme
emeraldguitars.com/ambassador-program/



Find An Ambassador

As an Emerald Guitars owner you have experienced first hand how different and special Emerald Guitars are but what truly makes Emerald special is the family of enthusiastic owners around the world who have helped spread the word about what makes a carbon fiber Emerald Guitar so unique and special.



Warranty

To help protect your investment, Emerald Guitars provides this limited warranty. If your guitar ever develops a problem that you believe is covered under warranty, feel free to contact us via e-mail; sales@emeraldguitars.com

Emerald Guitars warrants solely to the original retail purchaser of this Emerald musical instrument that the instrument purchased shall be free from defects in materials and workmanship under normal use for a period of three years from the date of purchase, or until the ownership of the instrument is transferred to another.

This Limited Warranty does not cover:

Normal wear and tear (i.e., worn machine heads, worn plating, string replacement, scratches or damages to or discoloration of the instrument finish for any reason).

The subjective issue of tonal characteristics.

Any instrument that has been damaged due to misuse, negligence, accident, or improper operation.

Any instrument upon which unauthorised repair or service has been performed.

Any factory-installed electronics after a period of one year following the original date of purchase.

Emerald does not warranty the playability of an instrument whose 'action' is lower than the factory standard or whose string gauge is different than the factory standard.

Limitation on Obligations

The obligations of Emerald hereunder are limited to repair or replacement of parts of the instrument found to be defective under this Warranty. In no event shall Emerald be liable for any indirect, incidental or consequential damages, including but not limited to time, wages or lost profits, of any nature or kind or for damages to or loss of property.

THIS WARRANTY IS THE SOLE WARRANTY OF R & J HAY LIMITED WITH REGARD TO EMERALD INSTRUMENTS, AND IS GIVEN IN LIEU OF ALL OTHER WARRANTIES, EXPRESS OR IMPLIED, INCLUDING ANY IMPLIED WARRANTIES OF MERCHANTABILITY AND FITNESS FOR PURPOSE.

No Other Warranties

The Warranty set forth herein constitutes the entire warranty and representation of Emerald with regard to its instruments. This Warranty shall be controlling over any conflicting terms and conditions of any purchase orders, contracts or invoices that may be executed in connection with the purchase of the Emerald musical instrument.

No representation or warranty made by any Emerald salesperson, representative or employee shall be binding upon Emerald other than as set forth herein.

Claim Procedures

Claims for warranty performance and service shall be made by sending the instrument, shipping and insurance prepaid by the purchaser, to the Emerald factory accompanied by:

Evidence confirming the original purchase by purchaser (such as a copy of the sales invoice, receipt or the like).

A brief description of the nature of the asserted defect.

The name, address and phone number of the original purchaser to whom the instrument is to be returned

Emerald Guitars shall review the description of the asserted defect, examine the instrument, and make service, repairs and replacements as appropriate under this Warranty. Upon completion of the service, the instrument shall be returned by Emerald to the original purchaser, return shipping will be covered by Emerald.

In the event it is determined that the asserted defect is not covered by or is excluded from this Warranty, the instrument shall be returned without repairs or can be repaired for an agreed fee. Shipping to be paid by the purchaser.

Warning

Although Emerald Guitars are incredibly strong and stable, neglect and improper use can cause considerable damage. It is advised that the same care be given to this instrument as any other fine guitar.

So that's the official warranty but if you have any problems please contact us and we will do everything in our power to rectify your situation by the best means possible.





Stay connected with everything happening at Emerald Guitars by
visiting our website: emeraldguitars.com